

# CONNECTORS AND ADAPTERS

Over 40 years of interconnect experience, from the first industry standard 905 Series SMA to the small form-factor connector system and high density MPO multi-fiber interconnects, Amphenol leads innovation in fiber optic connector technology.

## Highest Quality Materials

Top grade ceramic ferrules ensure the best optical performance and polishing yield. Carefully selected engineered plastics withstand the most demanding environmental stress conditions. High quality materials ensure the long-term reliability and performance of Amphenol connectors.

## Performance and Reliability

Amphenol Fiber Optic Products' experience in military and aerospace interconnect dictates 100% field reliability. Collaborative design review processes for new product development and a state of the art in-house environmental testing lab certify each Amphenol design and production process.

## Responsiveness and Speed to Market

Vertical and virtual integration (supplier partnerships) of key manufacturing processes allow for customer specific production of connector parts in less than four weeks: Stamping, Die Cast, Turning, Plastic and Metal Injection Molding, Plating, Reel to Reel Etching, Photolithographic and Laser MicroMachining.

## Manufacturing Expertise and Delivery Precision

Meticulous attention to capacity and material planning allow Amphenol to meet our committed ship dates on time, every time. Amphenol knows volume manufacturing. Rapid ramp-up of challenging new products is one of our strengths. From aerospace to oil exploration, from the Internet to medical devices, Amphenol Fiber Optic Products is a preferred supplier to leading customers across many industries.

## Global Presence

With 100 manufacturing facilities worldwide, and a local presence in over 30 countries, our responsive and creative team can solve your interconnect challenge anywhere in the world.



## Product Breadth

Amphenol Fiber Optic Products offers a complete line of fiber optic connectors and adapters including SMA, ST, FC, SC, LC, MPO and sealed connectors.

Total Quality Performance. Stringent quality assurance systems exceed the ISO:9001 requirements and ensure consistent quality products regardless of manufacturing location.





# PRODUCT TYPE

MPO Connector .....	3
LC Uniboot .....	5
LC Connectors .....	7
Micro LC Connectors .....	9
SC Connectors .....	11
FC Connectors .....	13
ST Connectors .....	15
H-Connector .....	17
IP-FX .....	19
R2CT .....	21
SC Adapters .....	23
MPO Adapters .....	25
LC Adapters .....	27
Stackable Adapters .....	29
Connector Boots .....	31

*The Experience and Reliability that Matter*

# MPO Connector

Amphenol manufactures a comprehensive line of MPO connectors that provide high density connections for the expanding Datacom marketplace.

A variety of boot and accessory options are available to assist with cable routing and end customer installation.

Amphenol MPO connectors meet TIA/EIA 604-5 and IEC 61754-7 intermateability standards.



## Features and Benefits

Available for a wide variety of cable designs and sizes

Available for Singlemode and Multimode fiber types

2 and 24 fiber count options

Standard and Low loss versions available

## Specifications

Insertion Loss:

≤ 0.75dB, Standard Singlemode

≤ 0.35dB, Low loss Singlemode

≤ 0.5dB Standard Multimode

≤ 0.35dB Low Loss Multimode

Return Loss:

Singlemode (APC) ≤ -55dB

## Applications

IT/Datacom

Data Centers

Wireless

## Industry Compliance

RoHS compliant

Meets TIA/EIA 604-5 intermateability standards

Meets IEC 61754-7 intermateability standards

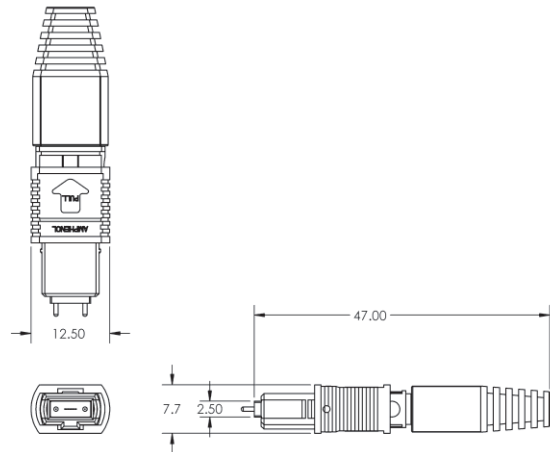

## Ordering Information

Part Number	Description
955-400-5C108	CONN, MPO, M/M, AQUA FEMALE, 3MM ROUND, 12F, BLACK BOOT
955-400-53108	CONN, MPO, S/M, GREEN FEMALE, 3MM ROUND, 12F, BLACK BOOT
955-410-5C108	CONN, MPO, M/M, AQUA MALE, 3MM ROUND, 12F, BLACK BOOT
955-410-53108	CONN, MPO, S/M, GREEN MALE, 3MM ROUND, 12F, BLACK BOOT

\*Please call customer service for additional configurations

## LC Uniboot

Amphenol's LC Uniboot connector simplifies cable routing in high density panels.

The compact design allows for greater density when populated in high density panels.

Amphenol Uniboot assemblies reduce congestion in racks and trays due to the one boot, one cable design.

Amphenol's LC connectors are a high density low cost solution without any sacrifice of performance.

The Amphenol LC Uniboot connectors are compliant to the EIA/TIA-604 and IEC 61754 industry standards.



### Features and Benefits

Optional Amphenol Push/Pull tab for installation in tighter spaces

Easy RJ45 coupling mechanism enables quick installation and the audible click signifies when connected

Pull proof design prevents signal interruption

Small form factor size enables increased density

UL-rated plastic housing and boot

Singlemode and Multimode versions

Available with 1.6/2.0mm, or 3.0mm standard and short boots

### Specifications

Insertion Loss:

≤ 0.75dB, Standard Singlemode

≤ 0.35dB, Low loss Singlemode

≤ 0.5dB Standard Multimode

≤ 0.35dB Low Loss Multimode

Return Loss:

Singlemode (APC) ≤ -55dB

Durability:

<0.2dB change

500 mating cycles

Temperature:

<0.3dB change, -40 to +85°C

### Applications

Data Communications

Wireless

IT/Datacom

Data Centers

### Industry Compliance

RoHS compliant

Connectors comply to applicable TIA/EIA and IEC intermateability standards

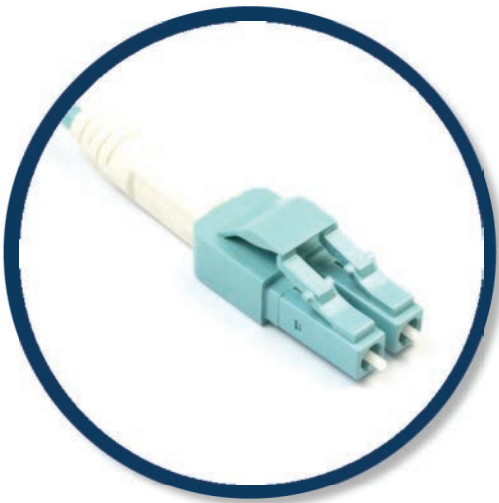

## Ordering Information

Part Number	Description
956-99013-50001	

\*Please call customer service for additional configurations

# LC Connectors

Amphenol's data communications fiber optic LC small form factor (SFF) connectors utilize the familiar RJ45 latching mechanism.

The LC connector is almost half the size of the popular SC connector, providing great space savings in the network.

With accelerated growth demanding greater bandwidth in less physical space, LC connectors have emerged as a viable solution for high density frames and patch panels.

Amphenol's LC connectors are a high density low cost solution without any sacrifice of performance.

Amphenol's LC connector portfolio includes Micro, Unibody, Uniboot and standard 2 piece LC connector designs.



## Features and Benefits

Optional Amphenol Push/Pull tab for installation in tighter spaces

Easy RJ45 coupling mechanism enables quick installation and the audible click signifies when connected

Pull proof design prevents signal interruption

Small form factor size enables increased density

Duplex version utilizes a removable flexible clip providing a float between channels A and B

Singlemode and Multimode versions

Available with 900 $\mu$ m, 900 $\mu$ m Behind the Wall (BTW), Short, 1.6/2.0mm, or 3.0mm boots

Multiple boot color options

Angled boots also available (50 degree, 90 degree, and flexible boot from 0 to 90 degree)

## Specifications

Insertion Loss:

$\leq 0.15$ dB typical, S/M

$\leq 0.25$ dB typical, M/M

$\leq 0.35$ dB typical, M/M

Return Loss:

$\leq -55$ dB SM Ultra Polish (UPC)

Durability:

$< 0.2$ dB change

500 mating cycles

Operating Temperature:

-40 to +75°C

## Applications

Data Centers

IT/Datacom

Wireless

## Industry Compliance

RoHS compliant

Meets IEC 61754-20 intermateability standards

Meets TIA/EIA 604-10 intermateability standards

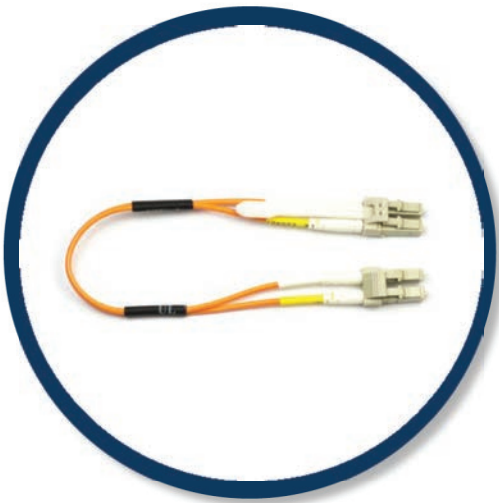
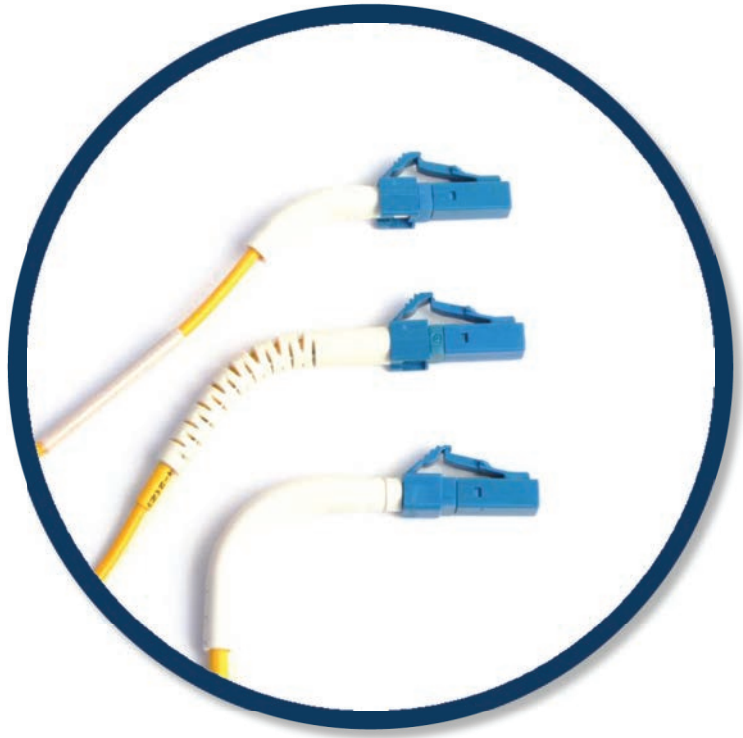
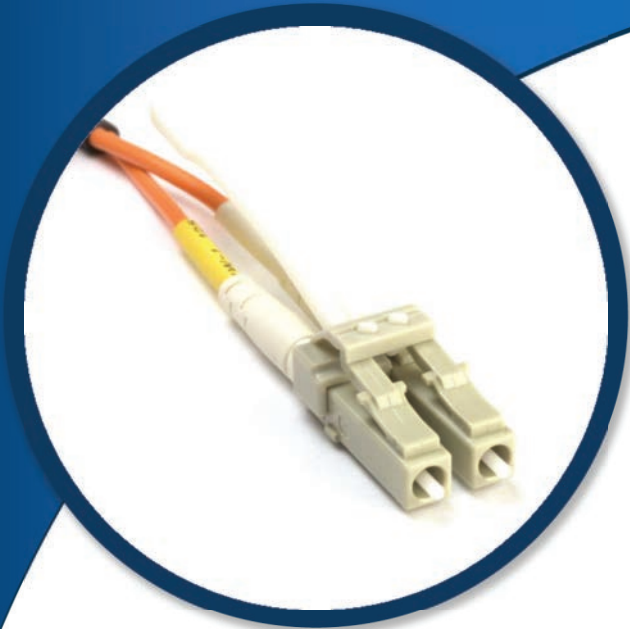

## Ordering Information

Part Number	Description
956-331-590314	LC SIMPLEX, SM, 125.5µm, BLUE
956-322-502214	LC DUPLEX, MM, 127µm, 1.6/2.0mm, BEIGE
956-312-502924	LC DUPLEX, MM, 127µm, 900µm

\*Please call customer service for additional configurations

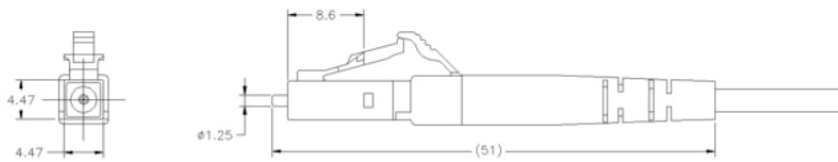

LC Simplex Connector with 1.6/2.0mm Boot

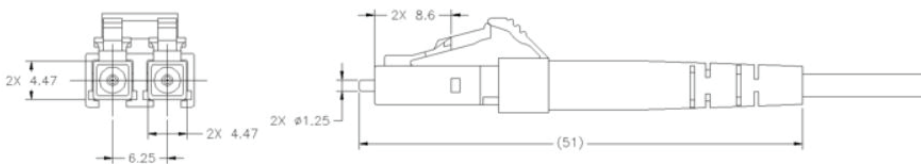

LC Duplex Connector with 1.6/2.0mm Boots

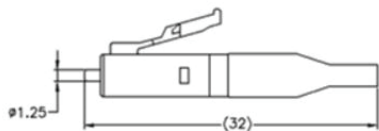

LC Simplex Behind the Wall (BTW) Connector with 900µm Boot



LC Duplex Connector with 900µm Boot



# Micro LC Connectors

Amphenol's Micro LC connector is one of the shortest LC connectors for jacketed cable on the market and reduces the total length of the connector and boot, providing great space savings in the network.

Amphenol's data communications fiber optic LC small form factor (SFF) connectors utilize the familiar RJ45 latching mechanism.

With accelerated growth demanding greater bandwidth in less physical space, LC connectors have emerged as a viable solution for high density frames and patch panels.

Amphenol's LC connectors are a high density, low cost solution without any sacrifice of performance.

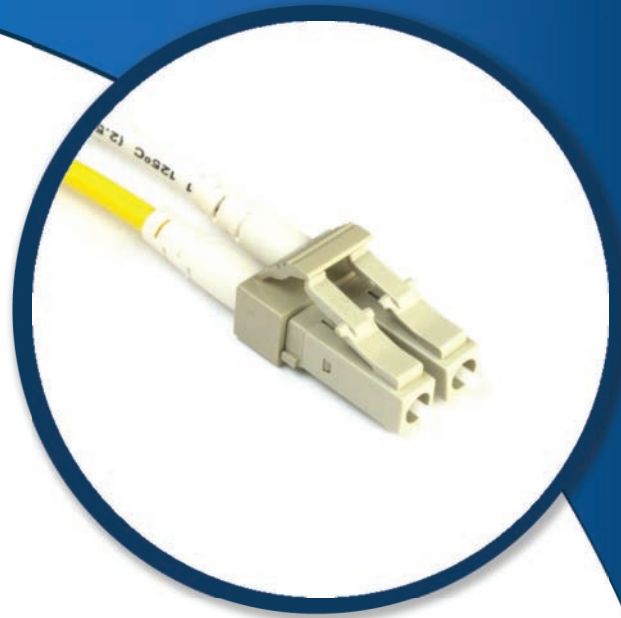

## Features and Benefits

Short LC connector and short boot for a total length of 36mm

One of the shortest LC connectors for jacketed cable on the market

Singlemode and Multimode versions

Duplex version utilizes a removable flexible clip providing a float between channels A and B

Multiple boot color options

## Specifications

Insertion Loss:

≤ 0.15dB typical, S/M

≤ 0.25dB typical, M/M

≤ 0.35dB typical, M/M

Return Loss:

≤ -55dB SM Ultra Polish (UPC)

Durability:

< 0.2dB change

500 mating cycles

Operating Temperature:

-40 to +75°C

## Applications

Data Centers

IT/Datacom

## Industry Compliance

RoHS compliant

Meets IEC 61754-20 intermateability standards

Meets TIA/EIA 604-10 intermateability standards

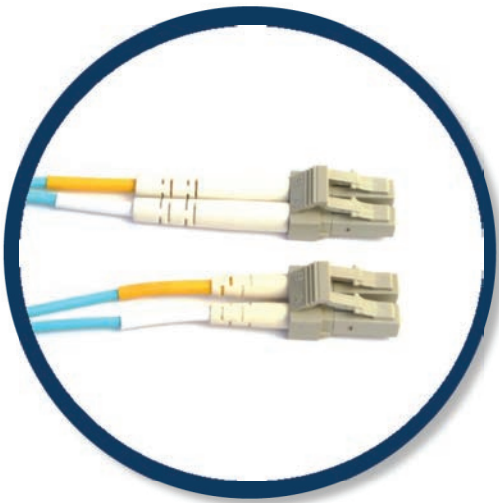
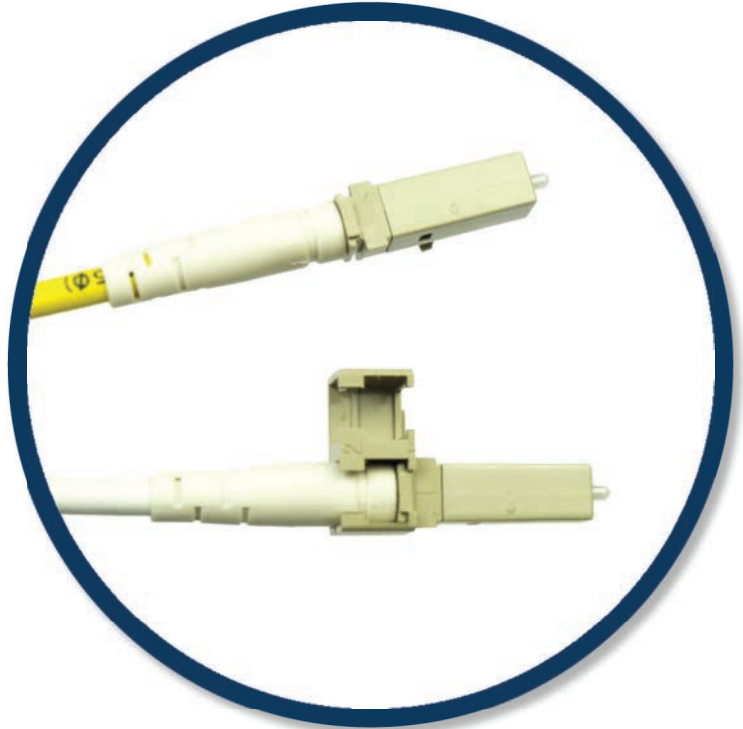
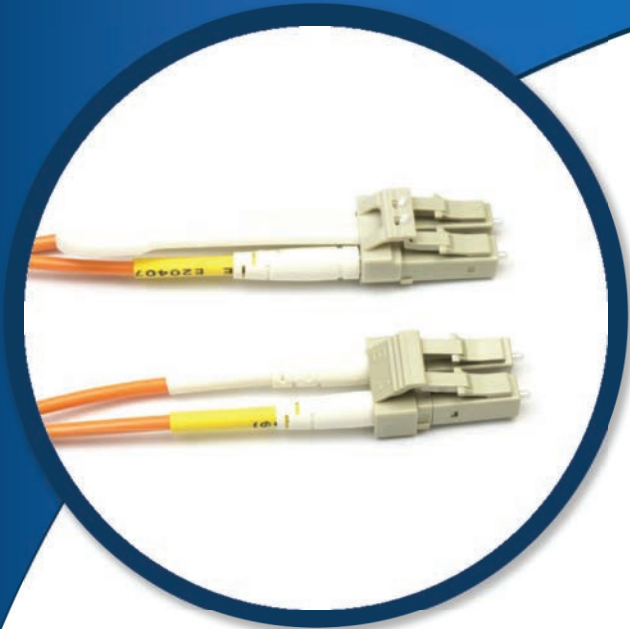

## Ordering Information

Part Number	Description
956-302-500204	LC MICRO SIMPLEX, MM, 127 $\mu$ m
956-301-590204	LC MICRO SIMPLEX, SM, 125.5 $\mu$ m
956-302-502204	LC MICRO DUPLEX, MM, 127 $\mu$ m

\*Please call customer service for additional configurations

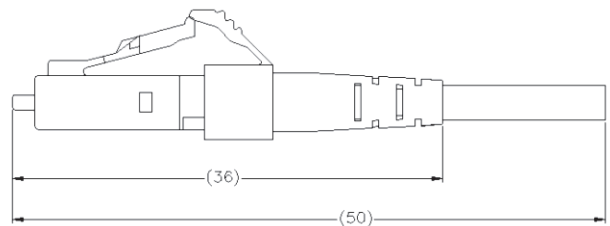
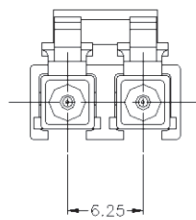
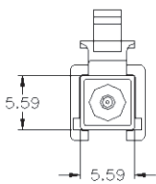

# SC Connectors

Amphenol's premier high performance fiber optic 954 Series SC connectors utilize a push pull retention feature enabling easy insertion and removal, making it ideally suited for network applications.

The SC connector features an internal cavity and epoxy injection tube that virtually eliminates the possibility of improper epoxy application, thus providing higher manufacturing yields and superior quality.

Amphenol's 954 Series SC connectors are compliant to the EIA/TIA-604-3, IEC 61754-4 industry standards, and are fully tested by a third party test lab per Telcordia GR-326 specifications.



## Features and Benefits

Easy push pull coupling mechanism enables quick installation and the audible click signifies when connector is locked in place

Pull proof design prevents signal interruption

Duplex version utilizes a removable flexible clip providing a float between channels A and B

High temperature and UL 94-V0 rated plastic housing and boots available in multiple colors

Available in Singlemode, angled Singlemode, and Multimode versions

Multiple boot size, colors and angle options available

## Specifications

Insertion Loss:

≤ 0.15dB typical, S/M

≤ 0.25dB typical, M/M

≤ 0.30dB typical, APC

≤ 0.35dB typical, M/M

Durability:

< 0.2dB change

500 mating cycles

Temperature:

< 0.3dB change, -40 to +85°C

## Applications

IT/Datacom

Data Communicatio

## Industry Compliance

RoHS compliant

Meets IEC 61754-4 intermateability standards

Meets TIA/EIA 604-3 intermateability standards

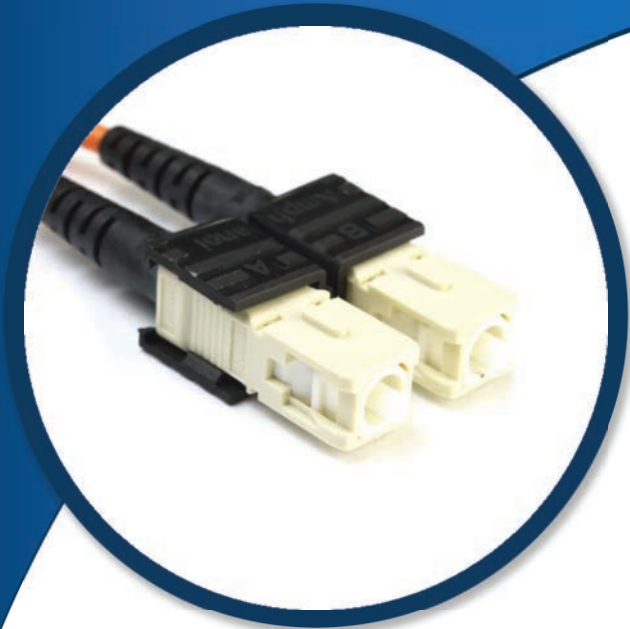

## Ordering Information

Part Number	Description
954-101-57203B	SC SIMPLEX CONNECTOR, MM
954-103-57393G	SC/APC SIMPLEX, SM, CONICAL FERRULE
954-101-58292B	SC DUPLEX CONNECTOR, SM

\*Please call customer service for additional configurations

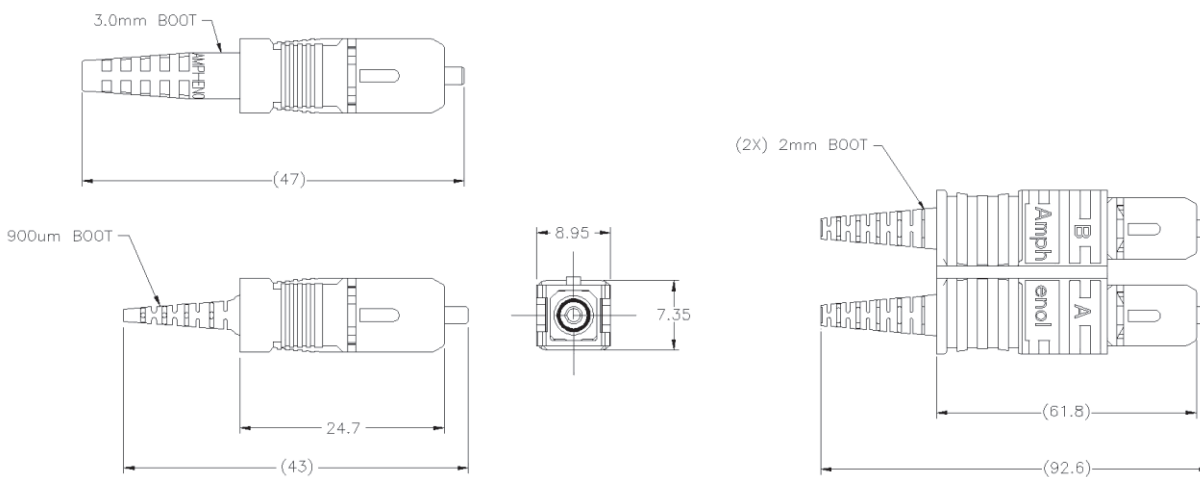

# FC Connectors

Amphenol's FC connectors effectively terminate optical fiber in a variety of network applications.

The connectors are secured using a threaded coupling nut, providing a significant increase in pull-out performance.

The FC/APC connector system features a tight fit keyway that prohibits the possible mismatching between the FC/PC and FC/APC connectors.



## Features and Benefits

One piece construction

Non-Optical disconnect feature design prevents signal interruption

Available in Singlemode, angled Singlemode, and Multimode versions

Available with 900 $\mu$ m, 2.0mm, or 3.0mm boots

## Specifications

Insertion Loss:

$\leq 0.15$ dB typical, S/M

$\leq 0.25$ dB typical, M/M

$\leq 0.30$ dB typical, APC

$\leq 0.35$ dB typical, M/M

Return Loss:

$\leq -55$ dB SM Ultra Polish (UPC)

$\leq -65$ dB Angle Polish (APC)

Temperature:

$< 0.3$ dB change,  $-40$  to  $+85^{\circ}\text{C}$

## Applications

Military

Industrial

IT/Datacom

## Industry Compliance

RoHS compliant

Meets IEC 61754-13 intermateability standards

Meets TIA/EIA 604-4 intermateability standards



### Ordering Information

Part Number	Description
944-601-53203B	FC CONN, MM, 128μm
944-603-53393G	FC/APC, SM, 125.5μm CONICAL FERRULE
944-601-53292L	FC CONN, SM, 125.5μm

\*Please call customer service for additional configurations

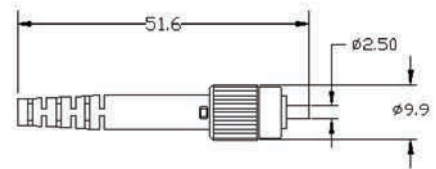
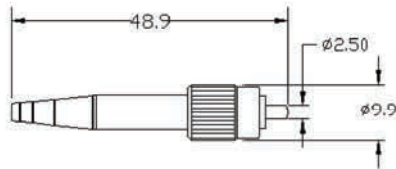
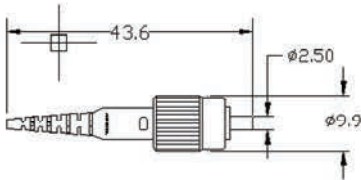

# ST Connectors

Amphenol's 953 Series fiber optic ST and ST II connectors utilize a bayonet style mating concept to provide a secure, robust coupling mechanism.

The enclosed spiral slotted coupling nut allows easy insertion in densely packed patch panels.

The ST connector is available with a plastic or die-cast body with a ceramic or stainless steel ferrule.



## Features and Benefits

The ST connector body and coupling nut are precision molded with a flame retardant polymer for a durable and light weight product

The STII connector body and coupling nut are precision zinc die cast and nickel plated for superior strength and corrosion resistance

Singlemode and Multimode versions

Available with 900µm, 2.0mm, or 3.0mm boots

Stainless steel ferrules also available on both the ST and STII connectors

## Specifications

Insertion Loss:  
≤ 0.15dB typical, S/M  
≤ 0.25dB typical, M/M  
≤ 0.35dB typical, M/M

Return Loss:  
≤ -55dB SM Ultra Polish (UPC)

Operating Temperature:  
-40 to +75°C

## Applications

Military

Industrial

IT/Datacom

## Industry Compliance

RoHS compliant

Meets TIA/EIA 604-2 intermateability standards



## Ordering Information

Part Number	Description
953-101-5306-P	ST II CONNECTOR, SINGLEMODE, 126μm
953-101-5310-P	ST II CONNECTOR, MULTIMODE, 128μm
953-101-5316-P	ST II CONNECTOR, SINGLEMODE, 126μm

\*Please call customer service for additional configurations

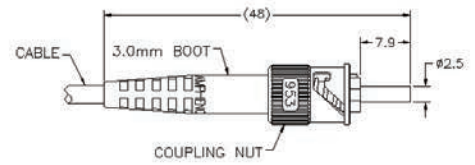
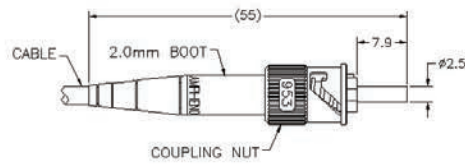
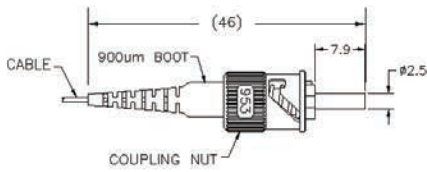



# H-Connector

Amphenol's H-Connector assemblies provide a robust and sealed connection solution for fiber to the home (FTTH) connectivity.

The H-Connector incorporates an SC/APC type connection within a slim, sealed, threaded polymer housing allowing easy connection to either a panel mounted receptacle or in-line extension cable.

Standard indoor SC/APC connectors mate to the adapter providing a common interface to mate with optical systems within an enclosure or Network Interface Device (NID).

Available with flat drop or traditional round style OSP cables, the H-Connector provides an ideal solution for direct burial, conduit or aerial installations.



## Features and Benefits

Factory terminated assemblies provide reliable performance

Plug dust cap with pulling eye protects connectors during installation

Threaded style coupling

## Specifications

Operating Temperature:  
-40° to 85°C

> 33 lb. axial cable retention (150N)

Cable Diameter Range:  
4.8mm to 7mm

Insertion Loss:  
≤ 0.35dB typical

Return Loss:  
≤ -55dB

## Applications

FTTH

FTTA

Outdoor Areas

Harsh Environment

## Industry Compliance

Connectors are mechanically and optically intermateable with industry standard connectors and adapters and conform to TIA/EIA, IEC, and Telcordia specifications

RoHS compliant

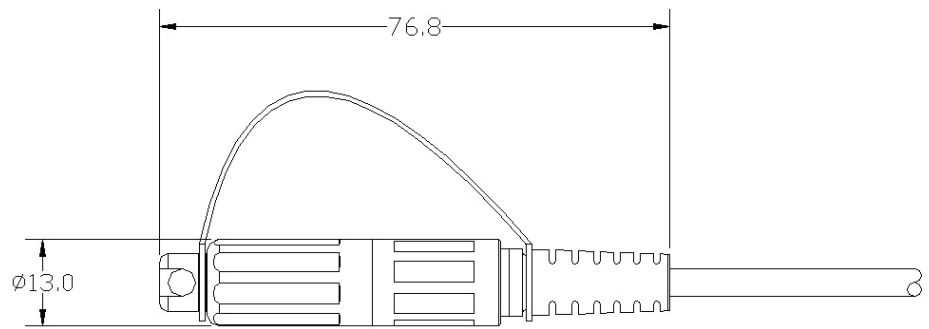

## Ordering Information

Part Number	Description
942-98468-10001	PIGTAIL, H-CONN FLAT DROP SM, 1M
942-98469-10001	PIGTAIL, H-CONN ROUND 7MM SM, 1M
942-98469-10001	PIGTAIL, H-CONN ROUND 7MM SM, 1M
942-98468-10001	PIGTAIL, H-CONN FLAT DROP SM, 1M
942-98469-10001	PIGTAIL, H-CONN ROUND 7MM SM, 1M

\*Please call customer service for additional configurations

## IP-FX

The Amphenol IP-FX is a compact, sealed, outdoor feed-thru housing that is designed to provide dust and water protection for assemblies mating to outdoor enclosures and transmission equipment. The IP-FX is suitable to protect several connector types including LC Duplex, RJ45, USB, and others.

The unique design of the IP-FX housing allows it to be supplied on factory terminated (tested cables) or field installed over existing cables such as LC Duplex or RJ45, making it an ideal solution for conversion from legacy systems to newer transmission equipment.

IP-FX housing mates to equipment or enclosures that are pre-fitted with the FullAXS-style receptacle, providing a water and dust sealed interface when mated.

Applications include connection to Remote Radio Units (RRU/RRH), FTTA equipment and other outdoor systems.



### Features and Benefits

- Factory or Field Installable version available
- Can be installed over existing outdoor assemblies
- Pass-Thru Design is suitable for many different connector types
- No tools required for installation
- Bayonet style coupling

### Specifications

- Operating Temperature:  
-40° to 85°C
- > 33 lb. axial cable retention (150N)
- Cable Diameter Range:  
4.8mm to 7mm
- Durability:  
>100 mating cycles

### Applications

- FTTA
- Small Cells
- Outdoor Areas

### Industry Compliance

- Connectors comply to applicable TIA/EIA and IEC intermateability standards
- GR-326 Issue IV
- RoHS compliant

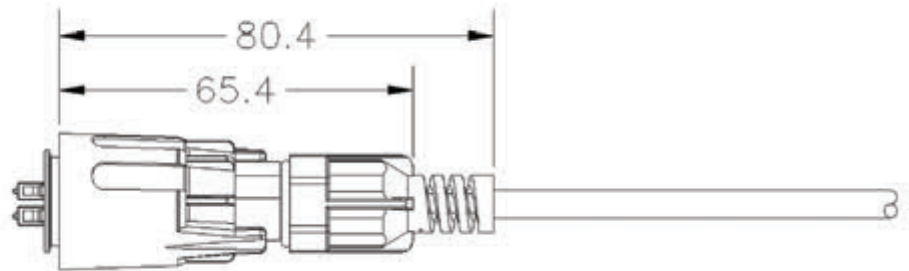

## Ordering Information

Part Number	Description
958-5000-1	KIT, IP-FX CONNECTOR, FACTORY FOR 4.8-6.0MM CABLE
958-5000-2	KIT, IP-FX CONNECTOR, FACTORY FOR 6.0-8.0MM CABLE
958-5001-1	KIT, IP-FX CONNECTOR, FIELD FOR 4.8-6.0MM CABLE
958-5001-2	KIT, IP-FX CONNECTOR, FIELD FOR 6.0-8.0MM CABLE
942-98473-10006	JUMPER, IP-FX TO LC DUPLEX (STD WITH 2MM BO)

\*Please call customer service for additional configurations

## R2CT

The R2CT Field Installable weatherproof housing is designed as a cost effective means of providing a removable interface for applications requiring protection from wet or dirty environments.

It allows for quick and easy installation onto Optical LC, RJ45, or other outdoor style communication assemblies. The system can be field assembled over previously deployed assemblies or provided on factory terminated assemblies for quick and reliable deployments.

The R2CT allows direct mating to edge mounted active devices or as a sealed feed-thru to adapters or internally mounted devices.

The R2CT Gland is also suitable for use as a feed-through interface for other type signal and fiber applications. Amphenol's R2CT Field Installable cable glands are exceptionally suited for WiMax, LTE, wireless, and base station applications.



### Features and Benefits

Field Installable

Can be installed over existing outdoor assemblies

Corrosion resistant aluminum housing

Plug dust cap with pulling eye protects connectors during installation

### Specifications

Operating Temperature:  
-40° to 85°C

Durability:  
>200 mating cycles

> 45 lb. axial cable retention (200N)

Cable Diameter Range:  
4.8mm to 7mm

### Applications

FTTA

Outdoor Areas

Harsh Environment

### Industry Compliance

Connectors are mechanically and optically intermateable with industry standard connectors and adapters and conform to TIA/EIA, IEC, and Telcordia specifications

RoHS compliant



## Ordering Information

Part Number	Description
957-5010	RECEPTACLE WITH VINYL DUST CAP
957-5001	R2CT PLUG (LONG) FOR OPTICAL
957-5011	RECEPTACLE WITH METAL SEALING CAP

\*Please call customer service for additional configurations

### R2CT Plug Assembly Details Optical or RJ45 Applications

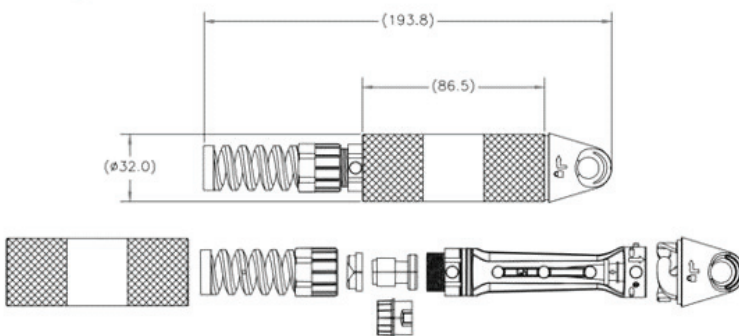

### Recommended Cable Breakout for Transceiver Applications

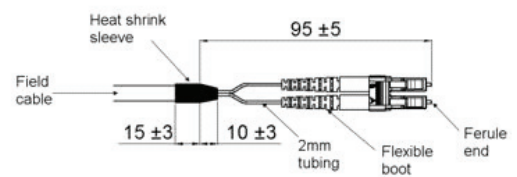

# SC Adapters

Amphenol's new and improved, complete range of premium SC adapter options provides the perfect solution for your network needs.

The one-piece plastic design is more robust than the typical two-piece design that is ultrasonically welded together.

The adapters meet EIA/TIA, IEC, and Telcordia standards. Options for Amphenol patented internal shutters\* and external door shutters are available.

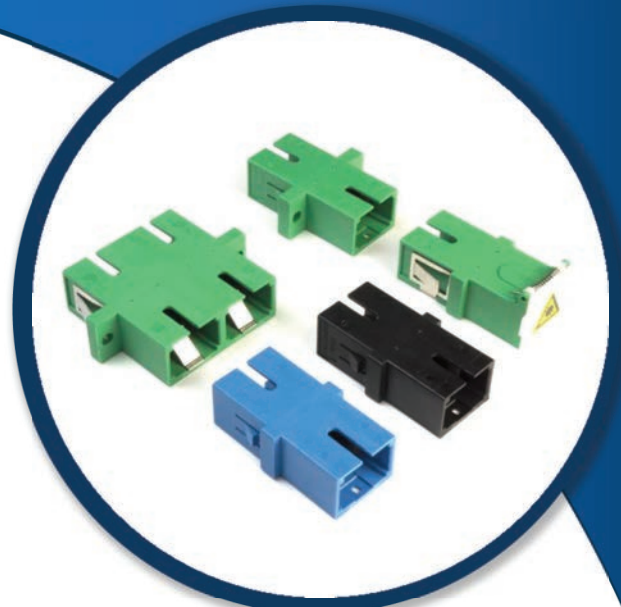

## Features and Benefits

One piece plastic body provides improved mechanical side load performance

Panel mounting clips molded into the plastic offer sturdy mounting support (metal mounting clip option is available upon request)

Made of a durable plastic material to meet the temperature extremes of Telcordia GR-326 standard

Amphenol's patented internal shutter option as well as an external door shutter version available

Multiple flange types, colors, and alignment sleeves are available

## Specifications

Durability:  
<0.2dB change  
500 mating cycles

Operating Temperature:  
-40 to +75°C

## Applications

Data Centers

IT/Datacom

## Industry Compliance

RoHS compliant

Meets IEC 61754-4 intermateability standards

Meets TIA/EIA 604-3 intermateability standards



### Ordering Information

Part Number	Description
954-180-50010	ADAPTER, SC SIMPLEX, BLUE
954-180-521E0	ADAPTER, SC DUPLEX, BEIGE
954-190-50130	ADAPTER, SC SIMPLEX, GREEN

\*Please call customer service for additional configurations

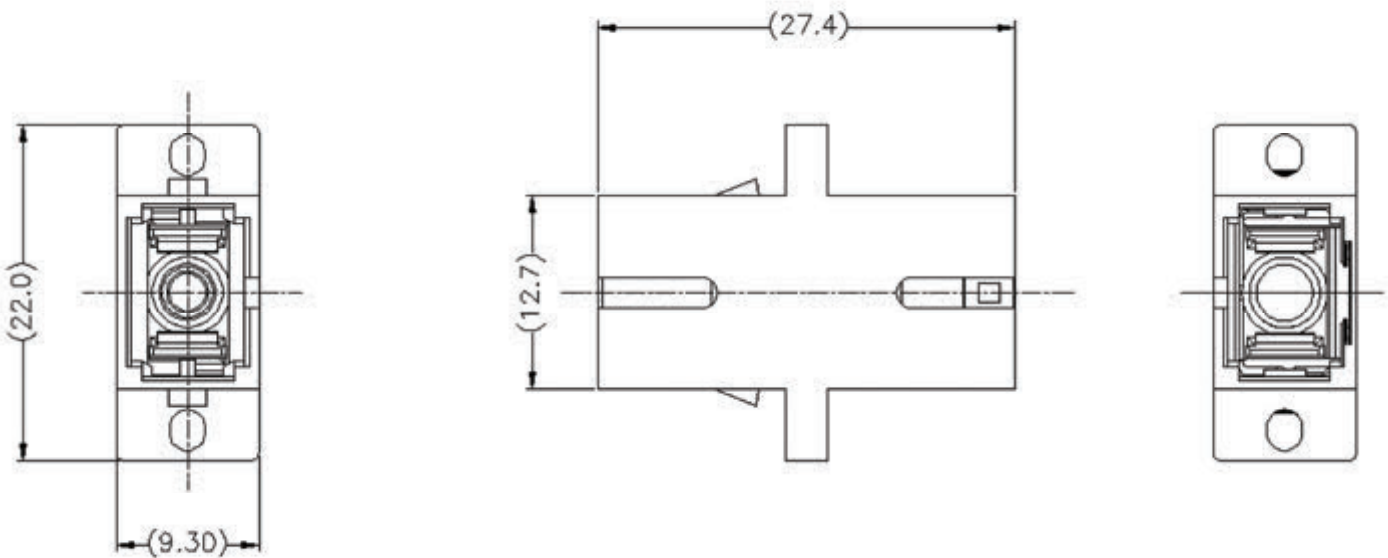



# MPO Adapters

Amphenol's MPO adapters are used to mate the high density MPO/MTP® connectors.

Made in both die-cast and thermoplastics, Amphenol MPO adapters are precision manufactured to ensure intermateability with industry standard assemblies and connectors.

Available with various flange styles, Amphenol MPO adapters meet the challenges and mechanical requirements of highly dense system designs while maintaining industry standard footprints.



## Features and Benefits

Accepts industry standard MPO/MTP® interfaces

Multiple flange options including standard, rotated, or reduced

Optional internal shutter mechanisms assist in eye safety requirements

Matched keyway option available

## Specifications

Durability:  
<0.3dB change  
500 mating cycles

Operating Temperature:  
-40 to +75°C

## Applications

Data Centers

IT/Datacom

## Industry Compliance

RoHS compliant

Meets IEC 61754-7 intermateability standards

Meets TIA/EIA 604-5 intermateability standards



## Ordering Information

Part Number	Description
955-121-5010	MPO DIE-CAST ADAPTER, STD FLANGE
955-121-5110	MPO DIE-CAST ADAPTER, STD FLANGE
955-121-5020	MPO DIE-CAST ADAPTER, ROTATED FLANGE

\*Please call customer service for additional configurations

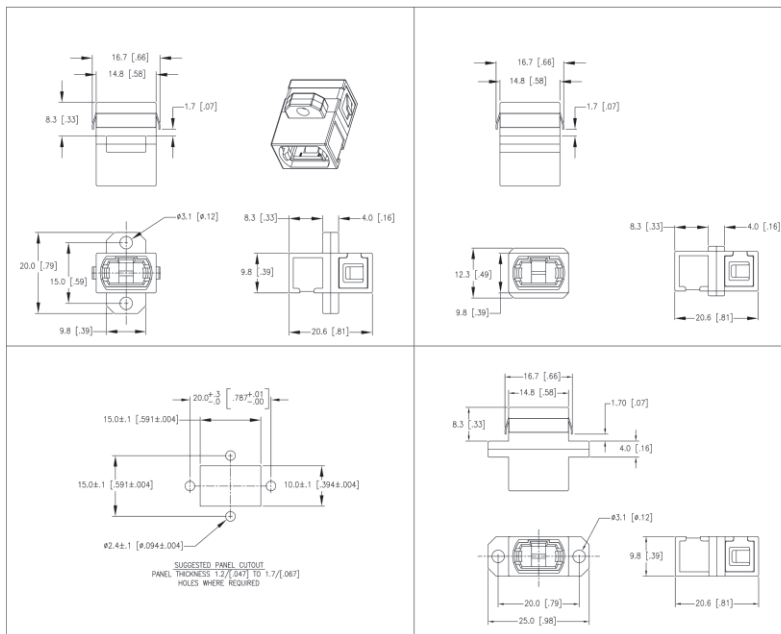

# LC Adapters

Amphenol's complete range of LC adapter options provides the perfect solution for your high density network needs.

The one-piece design is more durable than the typical two-piece design.

Amphenol LC adapters are for use with IEC 614754-20 and TIA/EIA 604-10 industry compliant LC connectors.

Amphenol patented internal shutters are available on most adapter types.



## Features and Benefits

Amphenol's patented internal shutter option as well as an external door shutter version available

Multiple flange types, colors, and alignment sleeves are available

Panel mounting clips molded into the plastic offer sturdy mounting support

Custom configurations available upon request

One piece plastic body provides improved mechanical side load performance

## Specifications

Durability:  
<0.3dB change  
500 mating cycles

Operating Temperature:  
-40 to +75°C

## Applications

Data Centers

IT/Datacom

Wireless

## Industry Compliance

RoHS compliant

Meets IEC 61754-20 intermateability standards

Meets TIA/EIA 604-10 intermateability standards

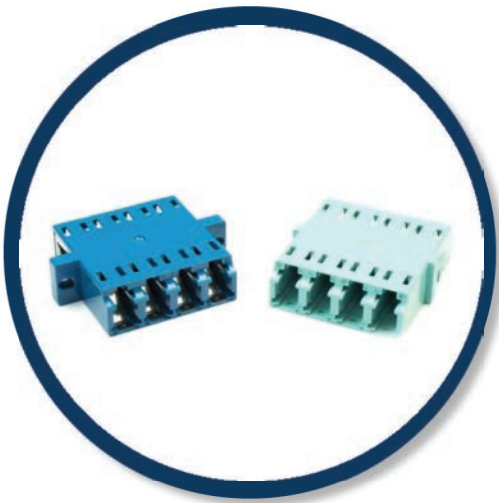

## Ordering Information

Part Number	Description
956-370-55010	ADAPTER, LC(D), BLUE, SC FOOTPRINT
956-380-550A0	ADAPTER, LC DUPLEX, AQUA
956-380-540A0	ADAPTER, LC QUAD, AQUA, SC FOOTPRINT

\*Please call customer service for additional configurations

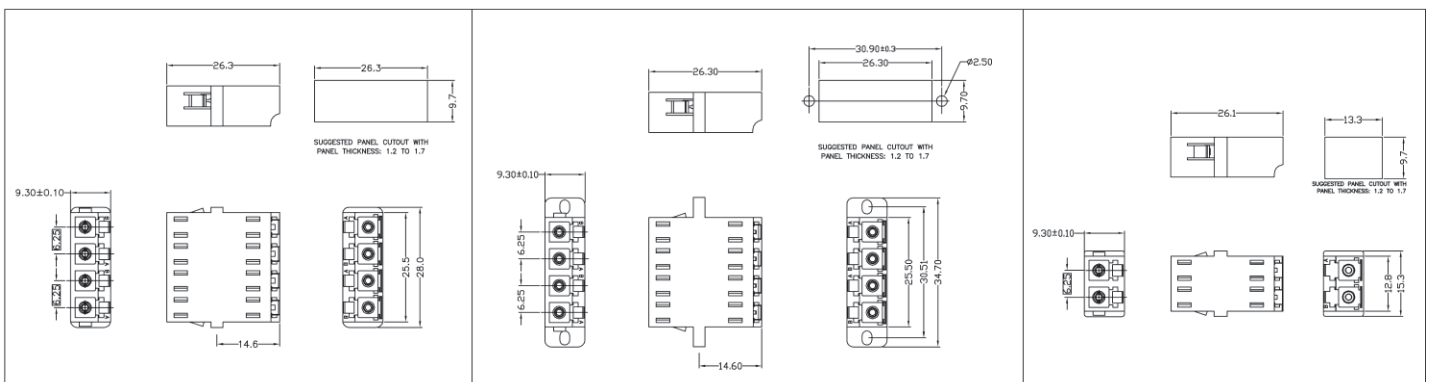

# Stackable Adapters

Amphenol's LC and MPO stackable adapter system is an innovative way to aggregate a high number of LC connections into a small footprint.

The stackable adapters are modular and allow network and equipment designers to improve fiber density. The stackable adapters have a track system for alignment and a permanent locking feature that prevents the adapters from coming loose.

Amphenol will preassemble the adapters into your custom configuration saving you time and ensuring the highest



## Features and Benefits

Modular design allows for custom configurations

Straight and 45° angled available

Amphenol's patented internal shutter option available

Accepts industry standard MPO/MTP® interfaces

Small form factor size enables increased density

## Specifications

Durability:

<0.3dB change  
500 mating cycles

Operating Temperature:

-40 to +75°C

## Applications

Data Centers

IT/Datacom

## Industry Compliance

RoHS compliant

Meets IEC 61754-7 intermateability standards

Meets IEC 61754-20 intermateability standards

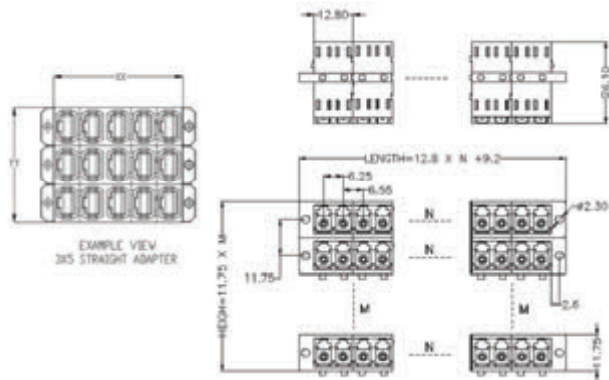
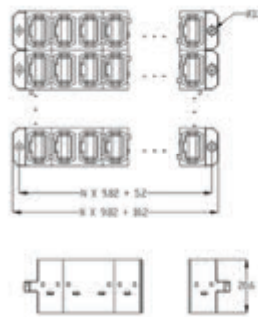
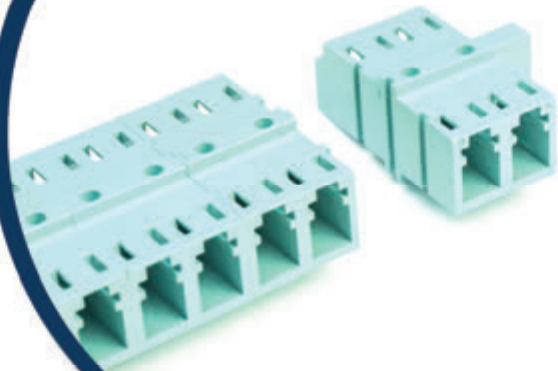

## Ordering Information

Part Number	Description
956-602-02013	ADAPTER, STACKABLE LC STR 1x2
956-602-02023	ADAPTER, STACKABLE LC STR 2x2
956-602-04013	ADAPTER, STACKABLE LC STR 1x4
956-602-06013	ADAPTER, STACKABLE LC STR 1x6
955-602-02010	ADAPTER, STACKABLE MPO 1x2
955-602-02020	ADAPTER, STACKABLE MPO 2x2
955-602-02040	ADAPTER, STACKABLE MPO 4x2
955-602-04010	ADAPTER, STACKABLE MPO 1x4
955-602-04020	ADAPTER, STACKABLE MPO 2x4

\*Please call customer service for additional configurations